

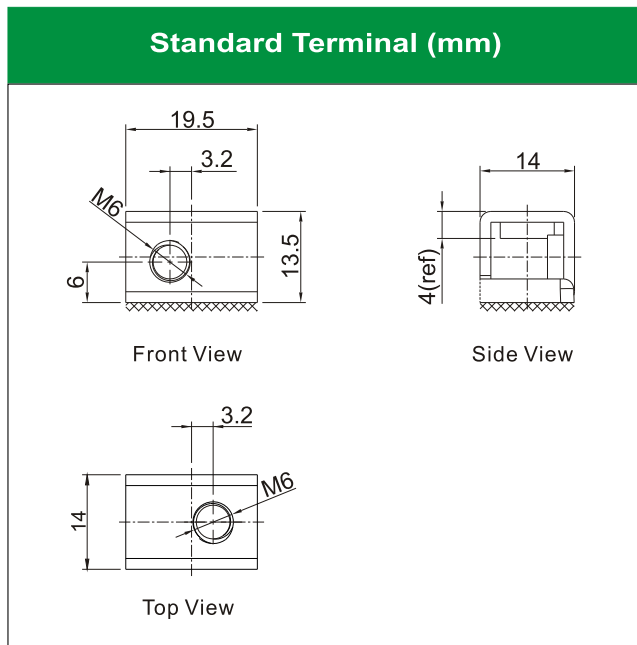

# MX30-3 [12V30Ah]

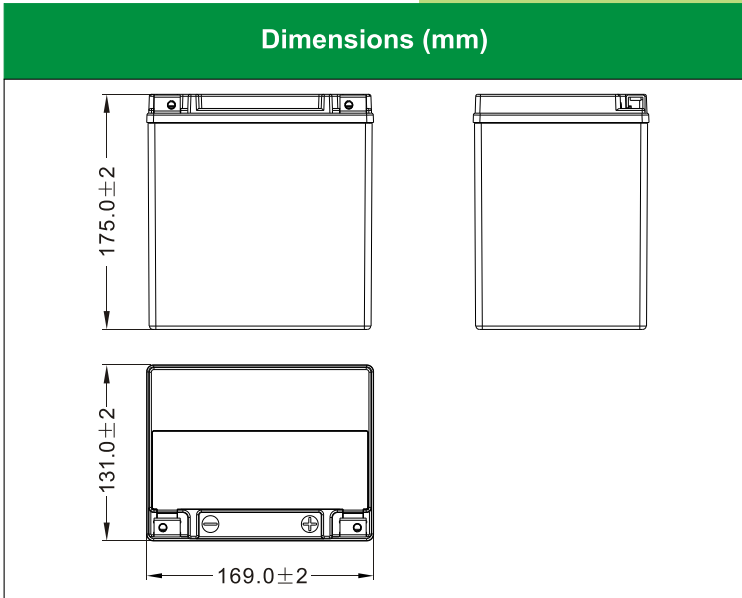

### Physical Specification

Nominal Voltage	12V	
Nominal Capacity (10HR)	30AH	
Dimension	Length	169 ± 2mm (6.65 inches)
	Width	131 ± 2mm (5.16 inches)
	Container Height	175 ± 2mm (6.89 inches)
	Total Height (with Terminal)	175 ± 2mm (6.89 inches)
Weight	Battery(with acid): Approx 9.9kg (21.83lbs) Electrolyte: Approx 2.0kg (4.41lbs)	

- \* Sealed and non-spillable AGM battery
- \* Maintenance-free
- \* Powerful 440 cold cranking amps
- \* Shipped pre-charged and ready to install

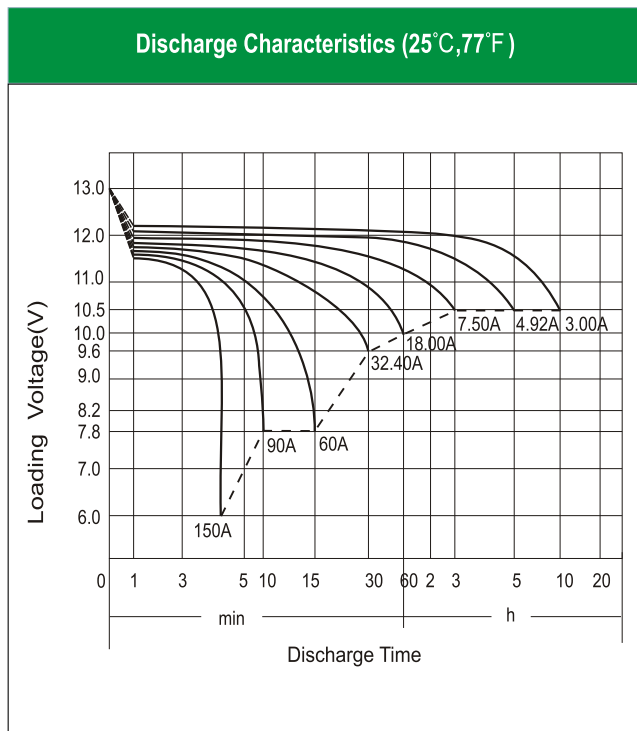

### Electrical Specification

Rated Capacity	10 hour rate (3.00 A)	30.00AH
	5 hour rate (4.92 A)	24.60AH
	2 hour rate (10.5 A)	21.00AH
	1 hour rate (18.0 A)	18.00AH
	0.5 hour rate (32.4 A)	16.20AH
Capacity affected by Temperature	40 °C (104 °F)	106%
	25 °C (77 °F)	100%
	0 °C (32 °F)	86%
	-15 °C (5 °F)	65%
Self Discharge	Approximately 3% per month (25°C (77°F))	
Charging Methods	Full Charge	Constant-Voltage Charge: Initial charging current: less than 9.0A Voltage: 14.40 V ~ 15.00 V at 25 °C (77 °F) Charging time: 15 ~18h Constant-Current Charge: Charging current: 0.1C <sub>10</sub> =3.00A, when charging voltage up to 14.40V, continue to charge 4h
	Floating Charge	No limit on Initial charging current Voltage: 13.50 V ~ 13.80 V at 25 °C (77 °F)