

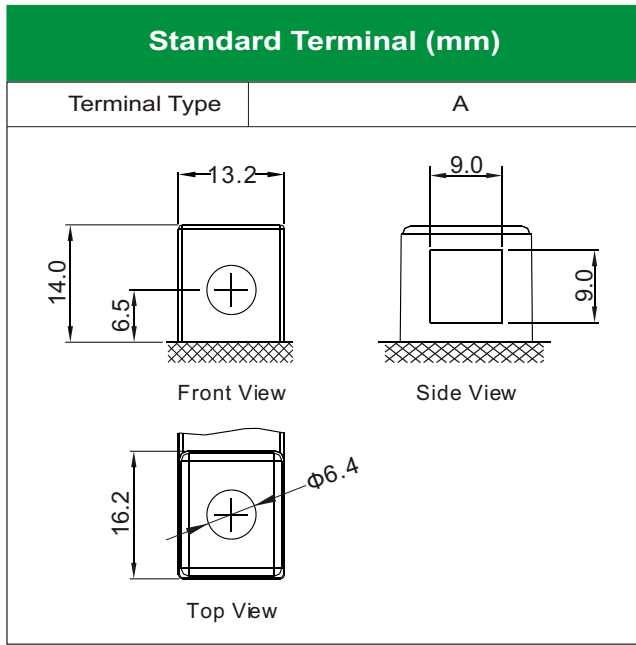

EBZ14-BS [12V11.2Ah]

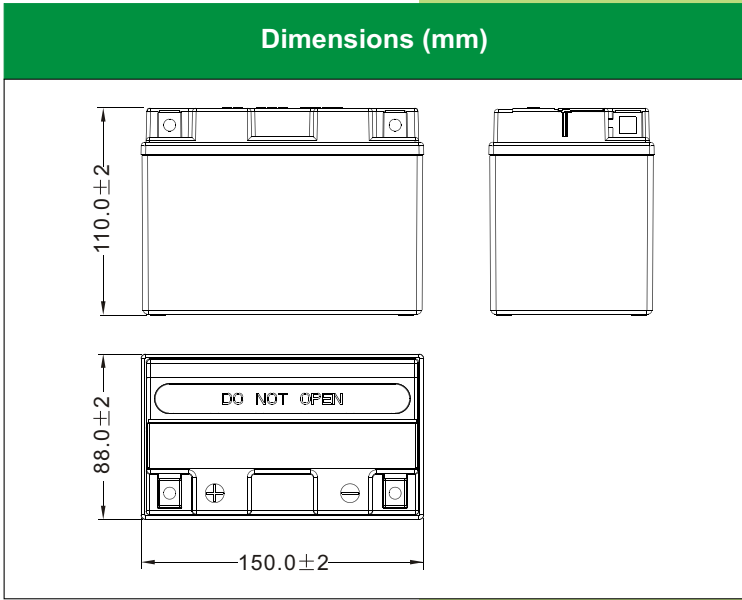

Physical Specification

Nominal Voltage	12V	
Nominal Capacity (10HR)	11.2AH	
Dimension	Length	150 ± 2mm (5.91 inches)
	Width	88 ± 2mm (3.46 inches)
	Container Height	110 ± 2mm (4.33 inches)
	Total Height (with Terminal)	110 ± 2mm (4.33 inches)
Weight	Battery(with acid): Approx 3.85kg (8.49lbs) Electrolyte: Approx 0.63kg (1.39lbs)	

- * Sealed AGM battery
- * Fresh Pack, Maintenance Free
- * Powerful 230 cold cranking amps
- * Rest after filling acid
- * Maximum tilt angle for installation: 25°

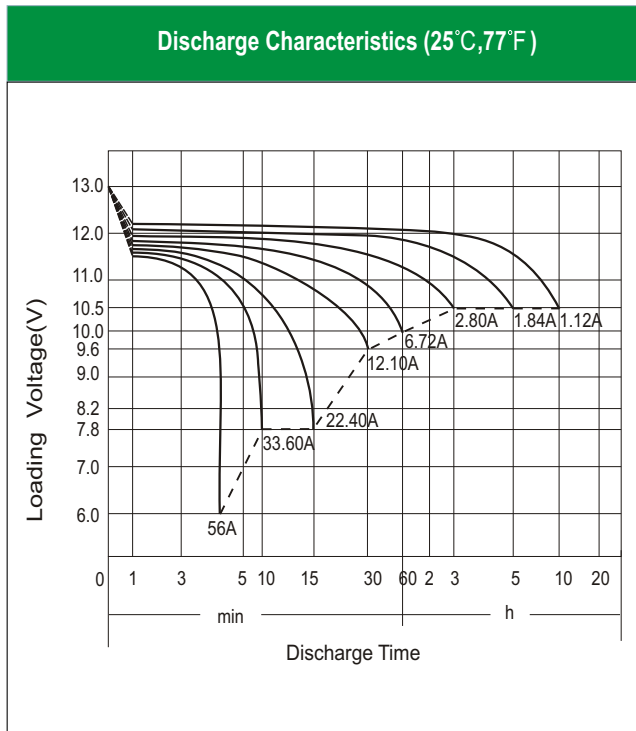

Electrical Specification

Rated Capacity	10 hour rate (1.12 A)	11.2AH
	5 hour rate (1.84 A)	9.18AH
	2 hour rate (3.92 A)	7.84AH
	1 hour rate (6.72 A)	6.72AH
	0.5 hour rate (12.10 A)	6.05AH
Capacity affected by Temperature	40 C (104 F)	106%
	25 C (77 F)	100%
	0 C (32 F)	86%
	-15 C (5 F)	65%
Self Discharge	Approximately 3% per month (25C (77F))	
Charging Methods	Full Charge	Constant-Voltage Charge: Initial charging current: less than 3.36A Voltage: 14.40 V ~ 15.00 V at 25 °C (77 °F) Charging time: 15 ~18h Constant-Current Charge: Charging current: 0.1C ₁₀ =1.12A, when charging voltage up to 14.40V, continue to charge 4h
	Floating Charge	No limit on Initial charging current Voltage: 13.50 V ~ 13.80 V at 25 °C (77 °F)