

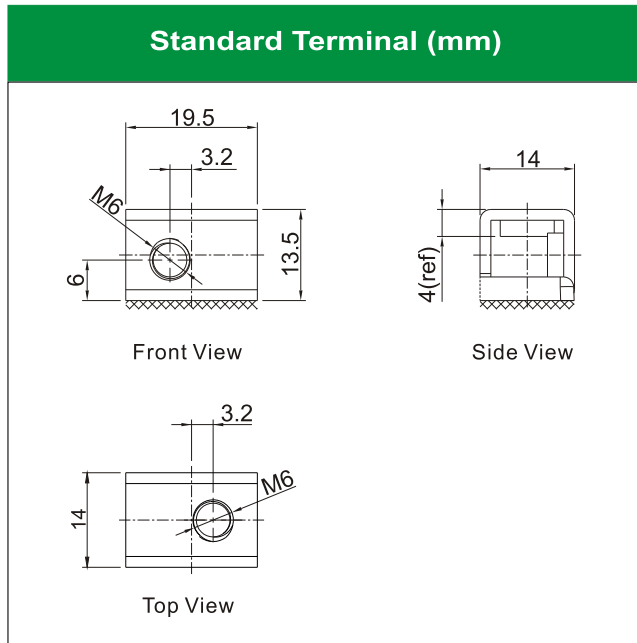

# MX9-4 [12V8Ah]

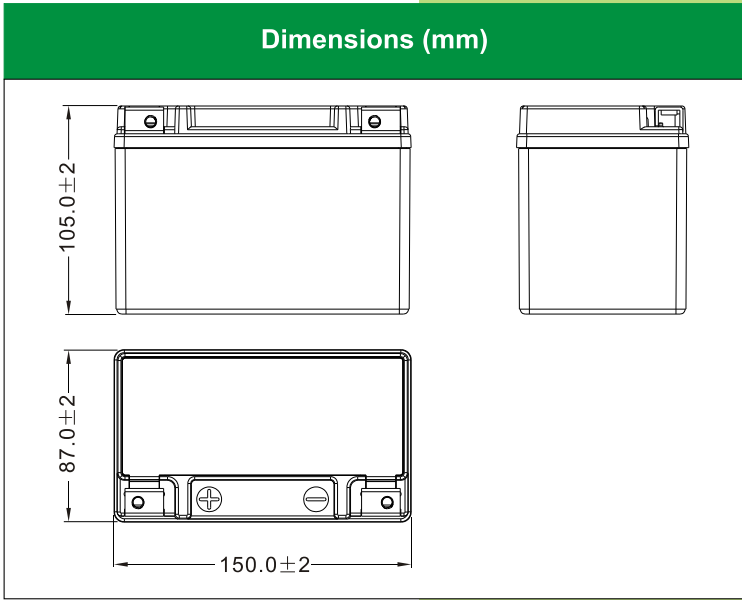

### Physical Specification

Nominal Voltage	12V	
Nominal Capacity (10HR)	8AH	
Dimension	Length	150 ± 2mm (5.91 inches)
	Width	87 ± 2mm (3.43 inches)
	Container Height	105 ± 2mm (4.13 inches)
	Total Height (with Terminal)	105 ± 2mm (4.13 inches)
Weight	Battery(with acid): Approx 3.05kg (6.73lbs) Electrolyte: Approx 0.6kg (1.32lbs)	

- \* Sealed and non-spillable AGM battery
- \* Maintenance-free
- \* Powerful 120 cold cranking amps
- \* Shipped pre-charged and ready to install

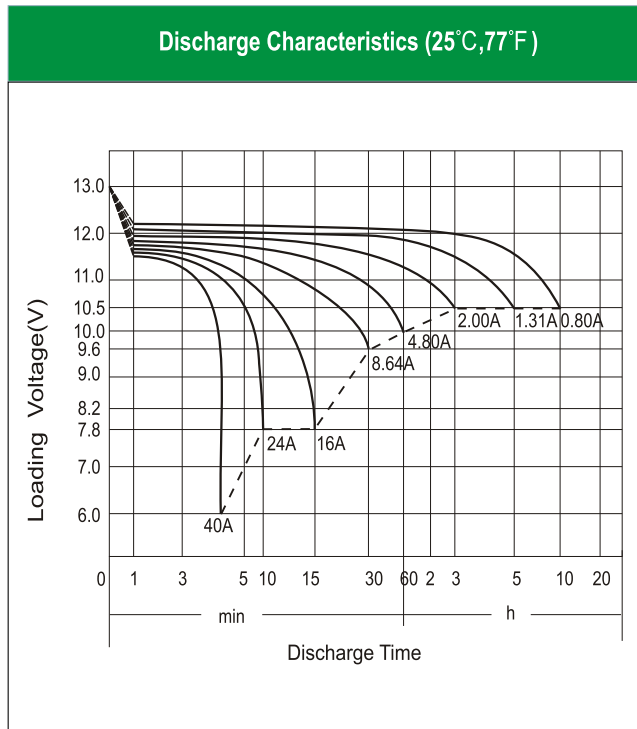

### Electrical Specification

Rated Capacity	10 hour rate (0.80 A)	8.00AH
	5 hour rate (1.31 A)	6.56AH
	2 hour rate (2.80 A)	5.60AH
	1 hour rate (4.80 A)	4.80AH
	0.5 hour rate (8.64 A)	4.32AH
Capacity affected by Temperature	40 °C (104 °F)	106%
	25 °C (77 °F)	100%
	0 °C (32 °F)	86%
	-15 °C (5 °F)	65%
Self Discharge	Approximately 3% per month (25°C (77°F))	
Charging Methods	Full Charge	Constant-Voltage Charge: Initial charging current: less than 2.4A Voltage: 14.40 V ~ 15.00 V at 25 °C (77 °F) Charging time: 15 ~18h Constant-Current Charge: Charging current: 0.1C <sub>10</sub> =0.8A, when charging voltage up to 14.40V, continue to charge 4h
	Floating Charge	No limit on Initial charging current Voltage: 13.50 V ~ 13.80 V at 25 °C (77 °F)